



<http://www.mir35.com>

**features and tunings
of some parts
of the new range
of carburetors**



DELORETO PH... CARBURETTORS

type	choke \varnothing	engine connection	air intake
PHBG...A	15-16-17-18-19-20	* \varnothing 24 - 26	\varnothing 32 - M 32x1,25
PHBG...B		● \varnothing 25	
PHBL...A	21-22-23-24-25	* \varnothing 28,57 - 31,75	\varnothing 38 - M 38x1,25
PHBL...B		● \varnothing 31	
PHBH...A	26-27-28-29-30	* \varnothing 35 - 37 - 40	\varnothing 42 - M 42x1,25
PHBH...B		● \varnothing 36	

* clip fitting ● flexible fitting

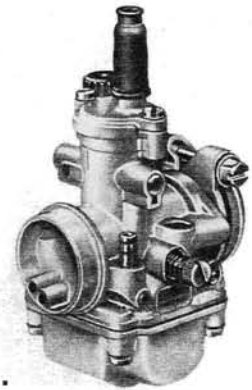

PHBG...

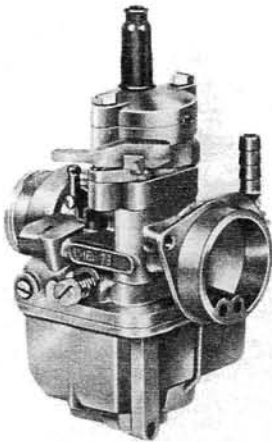

PHBL...

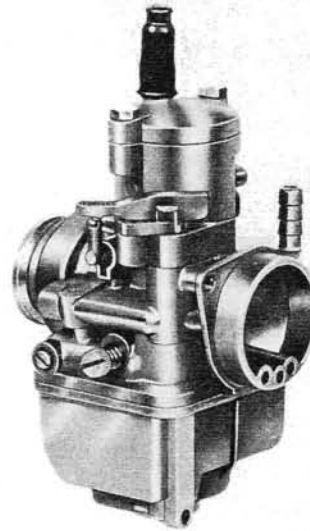

PHBH...

PHBE...

type	choke \varnothing	engine connection	air intake
PHBE...A	30-32-34-36	* \varnothing 42 - 45	M 48x1,25
PHBE...B	30-32-34-36	● \varnothing 44	\varnothing 48 - M 48x1,25
PHBE...H	30-32-34-36	● \varnothing 44	\varnothing 64
PHBE...P	30-32-34-36	● \varnothing 40	\varnothing 64

* clip fitting ● flexible fitting

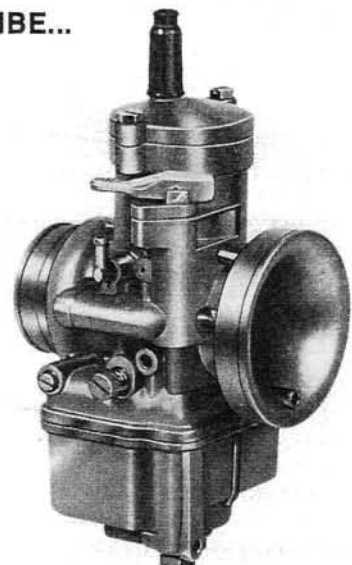

type	choke \varnothing	engine connection	air intake
PHF...A	30-32-34-36	* \varnothing 42 - 45	M 48x1,25
PHF...B	30-32-34-36	● \varnothing 44	\varnothing 46,5 - M 48x1,25

* clip fitting ● flexible fitting

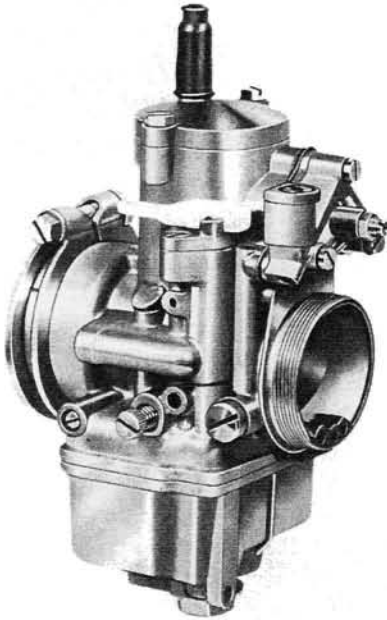

PHF...

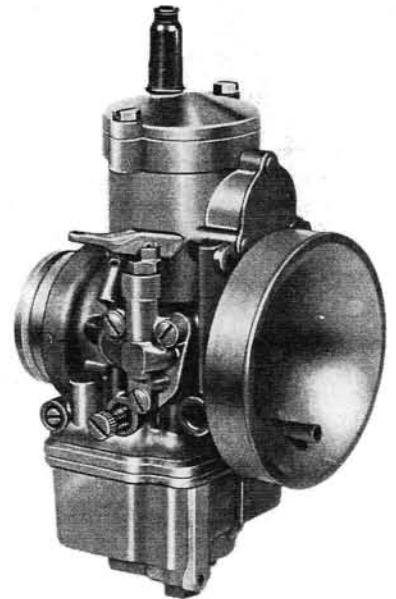

PHM...

type	choke \varnothing	engine connection	air intake	pump
PHM...B	38-40	* \varnothing 45 - 48	M 52x1,25	yes
PHM...E	38-40	● \varnothing 46	M 52x1,25	no
PHM...H	38-40-41	● \varnothing 46	\varnothing 64 - 83	no
PHM...N	38-40	● \varnothing 46	M 52x1,25	yes

* clip fitting ● flexible fitting

NEEDLE VALVES

carburettor	code No.	x value (seat \varnothing) (measured in hundredths of a mm.)
PHBL-PHBH	9436 x 33	200
PHBE-PHF-PHM	8649 x 33	250-270-300
PHF	8982 x 33	420



9436 x 33
8649 x 33
8982 x 33

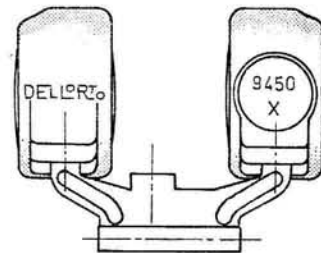

9450 x 80

FLOATS

carburettor	code No.	weight (gr.)
PHBG	9450.01.80	4
	9450.02.80	5
PHBL-PHBH	9010.01.80	11
	9010.02.80	8
PHBE-PHF-PHM	7450.01.80	10
	7450.02.80	14
PHBE-PHM	n. 2 9794.01.80	3,5

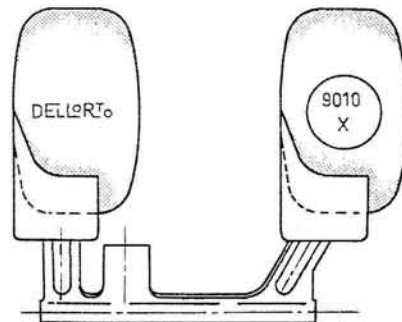

9010 x 80

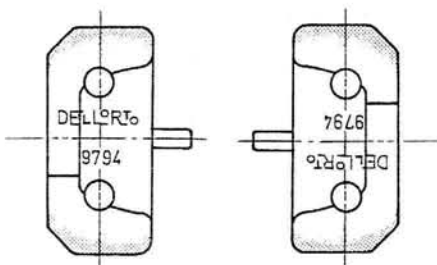

9794 x 80

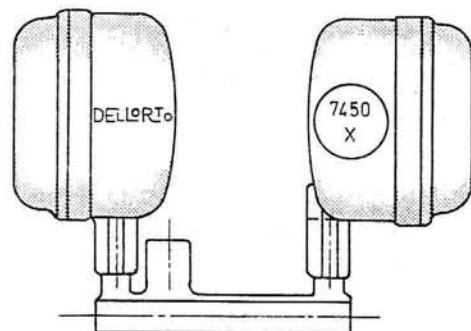

7450 x 80

JETS



1488 x 02



1486 x 02

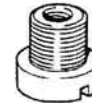

6413 x 02

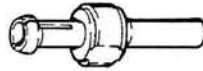

7851 x 02



9501 x 02



7746 x 02

code No.	carburettor	x value (measured in hundredths of a mm.)
1488 x 02	PHBG	30-32-35-38-40-42-45-48 50-52-55-60-65-70
1486 x 02	PHBG-PHBL PHBH-PHBE PHF-PHM	35-38-40-42-45-48-50 52-55 185-188-190
6413 x 02	PHBL-PHBH PHBE-PHF PHM	70-72-75-78-80-82-85 88-90 192-195-198-200 205-210 290-295-300 310-320-330
7851 x 02	PHF-PHM	30-33-35-38-40-42-45 48-50-55-60
9501 x 02	PHBG	35-40-45-50-55-60-65-70
7746 x 02	PHBL-PHBH PHBE-PHF PHM	45-50-55-60-65-70-75 80-85-90-100-110-120

TAPERED NEEDLES

PHBG carburettor

code No. 9595 x08

type	x value	(features measured in mm.)		
		ø A	ø B	C
W1	1	2,46	0,60	24
W2	2	2,46	0,60	22
W3	3	2,48	1,40	20
W4	4	2,48	1,40	18
W5	5	2,46	1,40	18
W6	6	2,50	1	24
W7	7	2,50	1,40	18
W8	8	2,50	1,40	16
W9	9	2,50	1,40	20
W10	10	2,50	1,80	16
W11	11	2,50	1,80	18
W12	12	2,50	1,80	20
W13	13	2,50	0,60	22
W14	14	2,50	0,60	24
W15	15	2,50	0,60	26
W16	16	2,50	1	22
W17	17	2,50	1	26
W18	18	2,48	0,60	24
W19	19	2,50	1,80	20
W20	20	2,50	1,60	24

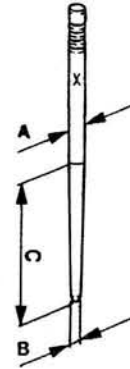

PHBH carburettor

code No. 9477 x08

type	x value	(features measured in mm.)		
		ø A	ø B	C
X1	1	2,48	1,20	26
X2	2	2,50	1,80	24
X3	3	2,46	1,60	22
X4	4	2,48	1,80	20
X5	5	2,46	1,80	24
X6	6	2,50	1,20	26
X7	7	2,50	1,80	20
X8	8	2,50	1,40	26
X9	9	2,50	1,40	18
X10	10	2,50	1,40	20
X11	11	2,50	1,40	22
X12	12	2,50	1,80	18
X13	13	2,50	1,80	22
X14	14	2,50	0,80	24
X15	15	2,50	0,80	26
X16	16	2,50	0,80	28
X17	17	2,50	1,20	24
X18	18	2,50	1,20	28
X19	19	2,48	1,00	28
X20	20	2,42	1,00	22
X21	21	2,50	1,00	20
X22	22	2,48	1,20	28,5
X23	23	2,46	1,20	26
X24	24	2,50	1,00	30
X25	25	2,50	1,80	25
X27	27	2,48	1,40	20
X29	29	2,50	0,60	30
X31	31	2,48	1,20	28
X32	32	2,48	1,80	24
X33	33	2,50	1,00	32
X36	36	2,53	0,62	30
X37	37	2,53	0,60	30

PHBL carburettor

code No. 2265 x08

type	x value	(features measured in mm.)		
		ø A	ø B	C
D22	22	2,50	1,40	18
D23	23	2,46	1	22
D24	24	2,50	0,60	20
D25	25	2,50	1,40	16
D26	26	2,50	1,40	20
D27	27	2,50	1,80	16
D28	28	2,50	1,80	18
D29	29	2,50	1,80	20
D30	30	2,50	0,60	18
D31	31	2,50	0,60	22
D32	32	2,50	1	18
D33	33	2,50	1	20
D34	34	2,50	1	22
D35	35	2,46	1,40	18
D36	36	2,50	1,40	22
D37	37	2,50	1,40	24
D40	40	2,48	1	24
D41	41	2,52	1	24,5

PHBE - PHF - PHM carburettor

code No. 8530 x08

type	x value	(features measured in mm.)				
		ø A	ø B	C	ø D	E
K1	1	2,45	1,75	37	-	-
K2	2	2,45	1,75	42	-	-
K3	3	2,50	1,50	39	-	-
K4	4	2,45	1,50	39	-	-
K5	5	2,45	1,50	37	-	-
K6	6	2,45	1,75	39	-	-
K7	7	2,45	1,25	39	-	-
K8	8	2,50	1,50	37	-	-
K9	9	2,45	1,50	42	-	-
K11	11	2,50	1,25	39	-	-
K12	12	2,48	1,75	32	-	-
K13	13	2,45	1,25	38	-	-
K14	14	2,48	1,75	33	-	-
K15	15	2,50	0,60	36	-	-
K16	16	2,50	1,75	39	-	-
K17	17	2,42	1,75	40	-	-
K18	18	2,50	1,40	38	-	-
K19	19	2,50	1,40	40	-	-
K20	20	2,50	1,40	42	-	-
K21	21	2,50	1,80	38	-	-
K22	22	2,50	1,80	40	-	-
K23	23	2,50	1,80	42	-	-
K24	24	2,50	1,20	38	2,13	18
K25	25	2,50	1,00	36	2,15	18
K27	27	2,50	1,80	44	-	-
K28	28	2,50	1,80	41	-	-
K29	29	2,45	1,25	42	-	-
K30	30	2,50	1,40	36	2,15	18
K32	32	2,48	1,70	44	-	-
K33	33	2,50	1,80	44	-	-
K34	34	2,50	1,40	40	2,11	18
K35	35	2,50	1,40	43	-	-
K36	36	2,50	1,40	38	2,17	20
K37	37	2,50	1,40	39	2,12	18
K38	38	2,50	1,40	38	2,13	18
K39	39	2,48	1,45	36	2,28	26

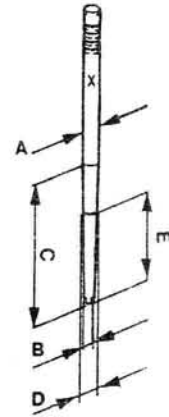

PHBE ... P carburettor

code No. 9713 x08

type	x value	(features measured in mm.)				
		ø A	ø B	C	ø D	E
U1	1	2,46	1,40	40	-	-
U2	2	2,50	1,80	40	-	-
U3	3	2,50	1,40	34	-	-
U4	4	2,50	1,40	38	-	-
U5	5	2,50	1,40	40	-	-
U6	6	2,50	1,40	42	-	-
U7	7	2,50	1,80	38	-	-
U8	8	2,50	1,80	42	-	-
U9	9	2,48	1,00	28	2,16	18
U10	10	2,50	1,00	30	2,06	18
U11	11	2,50	1,00	28	2,11	16
U12	12	2,50	1,40	32	-	-
U13	13	2,45	1,20	28	-	-
U14	14	2,48	0,60	28	2,23	18
U15	15	2,50	1,20	32	-	-
U16	16	2,50	1,80	32	-	-
U17	17	2,50	0,60	36	-	-

ATOMIZERS

2 stroke engines

4- and 2- stroke engines

PHBG carburetors

code No.	type	x value measured in hundredths of a mm.
9654 x 28	AV	258-260-262-264-266
9511 x 28	AN	258-260-262-264-266
10245 x 28	BP	258-260-262

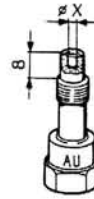

9654 x 28

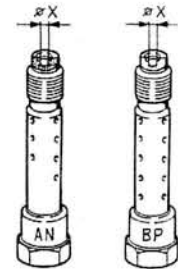

9511 x 28 10245 x 28

PHBL carburetors

code No.	type	x value measured in hundredths of a mm.
9564 x 28	AQ	260-262-264-266-268
8358 x 28	K	266-268-270
8566 x 28	D	266-268-270
8935 x 28	AE	266-268-270
9143 x 28	AG	260

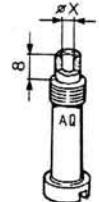

9564 x 28

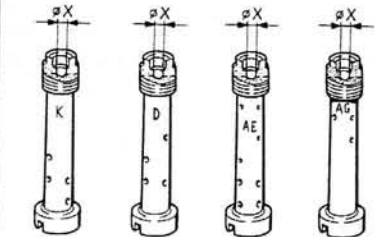

8358 x 28 8566 x 28 8935 x 28 9143 x 28

PHBH carburetors

code No.	type	x value measured in hundredths of a mm.
9695 x 28	AV	264-266-268-270
9423 x 28	AS	260-266-270
7790 x 28	P	266-268-270
7972 x 28	T	260-262-264-266-268-270
9979 x 28	BC	262

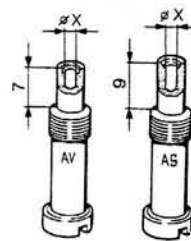

9695 x 28 9423 x 28

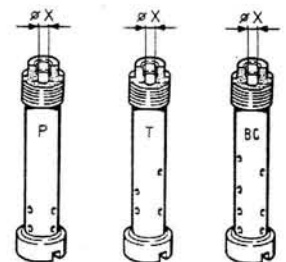

7790 x 28 7972 x 28 9979 x 28

PHBE - PHF - PHM carburetors

code No.	type	x value measured in hundredths of a mm.
8540 x 28	AB	260-262-265-268-270 272-275
8979 x 28	AF	330-340-350-360
9593 x 28	AR	260-262-265-270

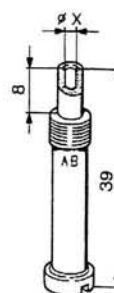

8540 x 28

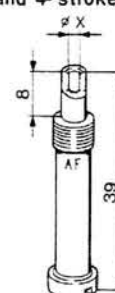

8979 x 28

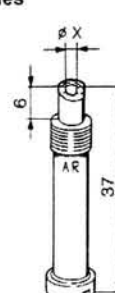

9593 x 28

2- and 4- stroke engines

THROTTLE SLIDES

carburettor	code No.	x value measured in tenths of a mm.
PHBG	9475 x 64	30-40-50-60
PHBL	9645 x 64	30-40-50-60
PHBH	9374 x 64	30-40-50-60-70
PHBE	9309 x 64	40-50-60-70

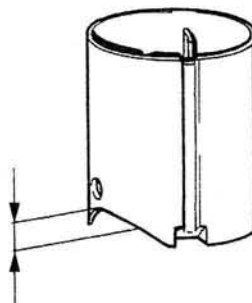

THROTTLE SLIDES FOR PHF AND PHM CARBURETTORS

Throttle slides for PHF carburettors have the part-number 8553 x 64 produced in different sizes (X) – 401-402-501-503-601-602-603-604-701-702.

Throttle slides for PHM carburettors have the part-number 8639 x 64 produced in different sizes (X) – 401-501-503-601-603-605-701.

These sizes are marked 40/1, 40/2, etc. on the lower part of the throttle valve castings.

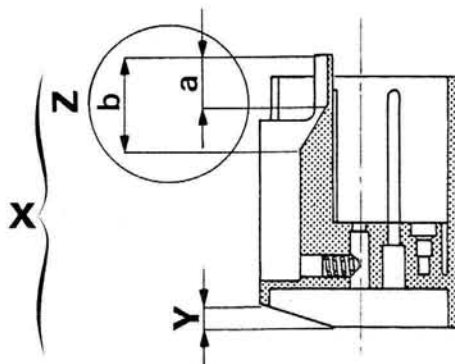

As you can see from the figure, the size value, 501, 601, etc., of these slides is formed by two elements Y and Z.

Y represents the cutaway size and Z in a symbol which is similar for both PHF and PHM slides and which determines the position and the variation of the pump operating cam.

The values of Z are:

z values	a	b
1	10	20
2	13	23
3	2	30
4	13	26
5	2	20

A throttle slide 8553.602.64 is therefore for a PHF carburettor and has a 60 cutaway (60mm) and with a pump control cam with the start of operation at 13 mm (dimension a) and the end of the pump action at 23 mm (dimension b).